

# Nanoparticles Research on four Gasoline Cars

J.Czerwinski, P.Comte  
AFHB, University of Applied Sciences,  
Biel-Bienne, CH

## GasOMeP ... Gasoline Organic & Metal Particles

Network project: EMPA, PSI, FHNW, AFHB, TTM

Support of: CCEM, BAFU, BfE,  
Swissoil, Swissslubes

## PRESENTED RESEARCH OF NP

- measurements at tailpipe & CVS tunnel
- 4 passenger cars, MPI & GDI, SMPS & CPC
- NP- emissions in legal driving cycles, cold & warm
- size selective analytics
- emission dispersion at  $v = \text{const}$

## Abstract

In the project GasOMeP (Gasoline Organic & Metal Particulates) metal-nanoparticles (including sub 20nm) from gasoline cars are investigated for different engine technologies.

In the present paper some results of investigations of nanoparticles from four gasoline cars – an older one with MPI and three never with DI – are represented. The measurements were performed at vehicle tailpipe and in CVS-tunnel.

The results show that the older vehicle with MPI emits high particle count concentrations. The size distributions of this vehicle are decisively bimodal with high numbers in nuclei mode.

The emissions of the newer vehicles with DI show sometimes no typical uniform shape of particle size distributions and are at lower level, than for the older vehicle. There is no visible nuclei mode and the ultrafine particle concentrations below 10nm are insignificant.

A size-selective analysis of the composition of NP's in NEDC revealed an increased amount of Na, Mg, Ca & Zn in the lowest size range, below 100nm.

Some of the newer, low-emitting vehicles show at constant speed operation a periodical fluctuation of the NP-emissions.

Increased NP-emissions at cold start were confirmed.

## GASOLINE VEHICLES FOR RESEARCH OF NP

Vehicle	Renault 18 Break	Audi A3 2.0 TFSI
Engine code	J71-718	BVA
Number and arrangement of cylinders	4 / in line	4 / in line
Displacement cm <sup>3</sup>	2164	1984
Power kW	74 @ 5000 rpm	147 @ 6000 rpm
Torque Nm	162 @ 2000 rpm	280 @ 1800 rpm
Injection type	MPI	DI
Curb weight kg	1110	1530
Gross vehicle weight kg	1585	1920
Drive wheel	Front-wheel drive	Front-wheel drive
Gearbox	m5	m6
First registration	01.04.1985	01.12.2006
Exhaust	EURO 0	EURO 4
VIN	VF1135B00F0000505	WALJZZ28P17A042987

## GASOLINE VEHICLES FOR RESEARCH OF NP

Vehicle	Volvo V60 T4F	Citroën C5
Engine code	B4164T2	EP6CDT (SF02)
Number and arrangement of cylinders	4 / in line	4 / in line
Displacement cm <sup>3</sup>	1596	1598
Power kW	132 @ 5700 rpm	115 @ 6000 rpm
Torque Nm	240 @ 1600 rpm	240 @ 1400-4000 rpm
Injection type	DI	DI
Curb weight kg	1554	1515
Gross vehicle weight kg	2110	1951
Drive wheel	Front-wheel drive	Front-wheel drive
Gearbox	a6	a6
First registration	27.01.2012	2013
Exhaust	EURO 5a	EURO 5a
VIN	YV1FW075B C1043598	VF7R05FVAB L503114

## Comparison of NP-emissions

## PARTICLE SIZE DISTRIBUTIONS OF DIFFERENT VEHICLES AT TAILPIPE & 40 KM/H

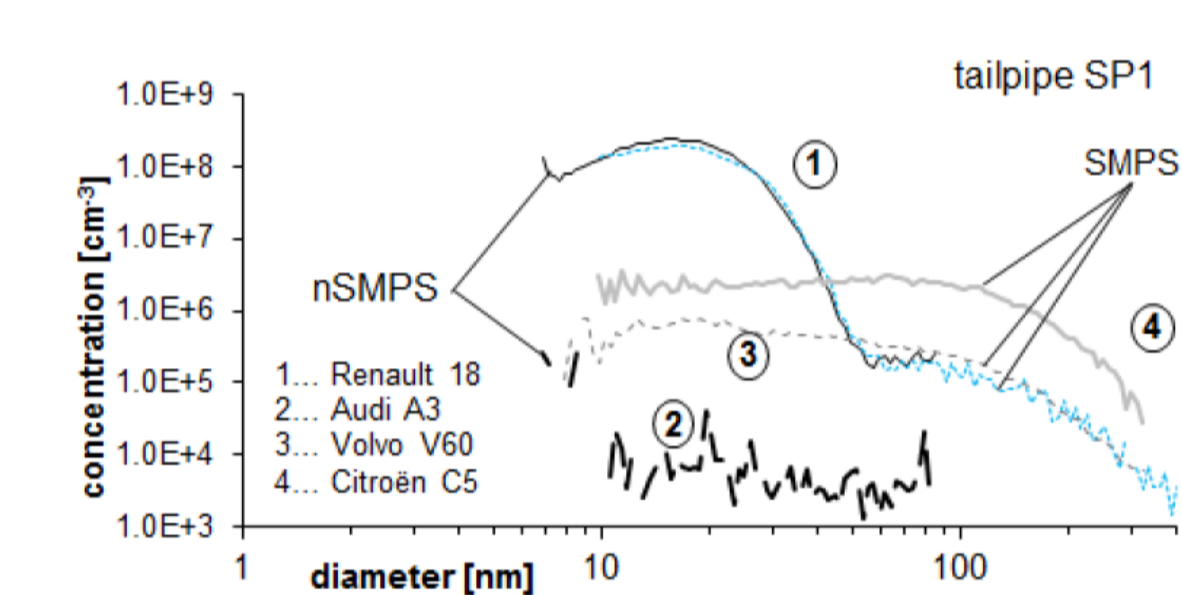

## Size-selective analytics

## ELPI BLOCK-DIAGRAM

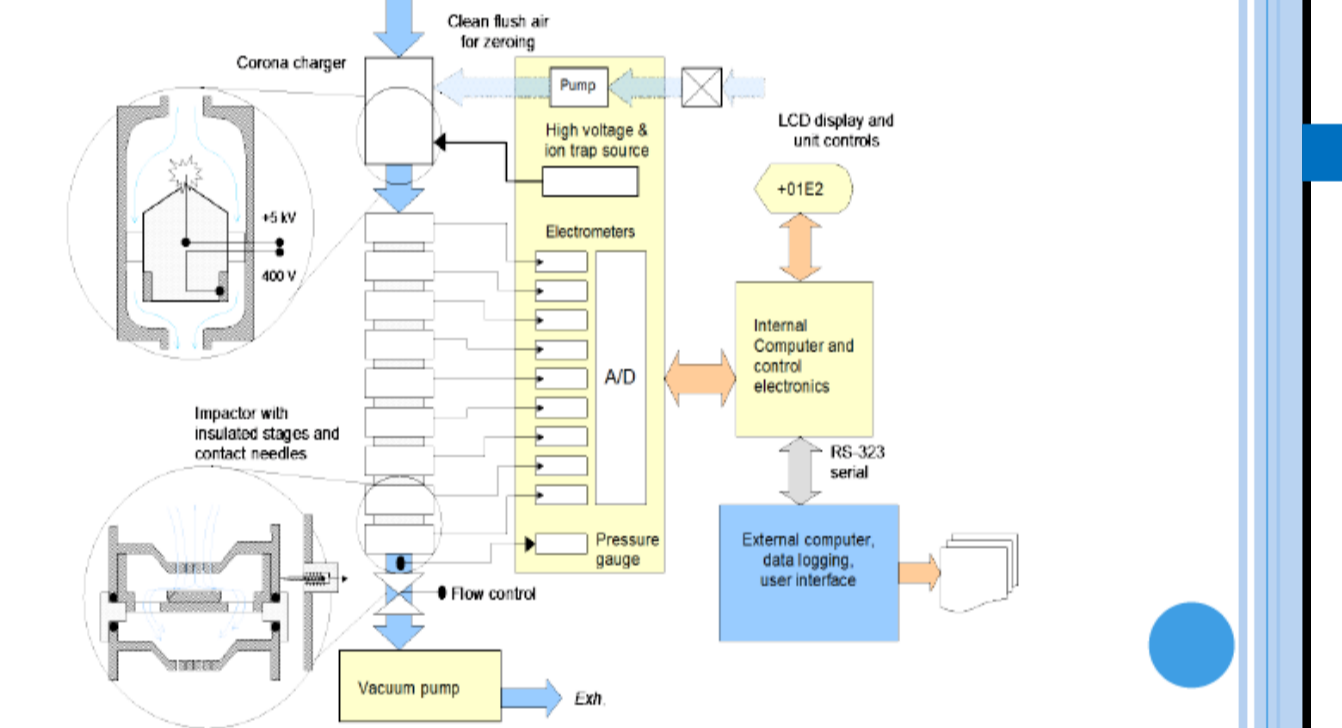

## NP-emissions cold & warm

## COMPARISON OF NP-EMISSIONS IN NEDC COLD AND HOT. VEHICLE 3; CVS TUNNEL

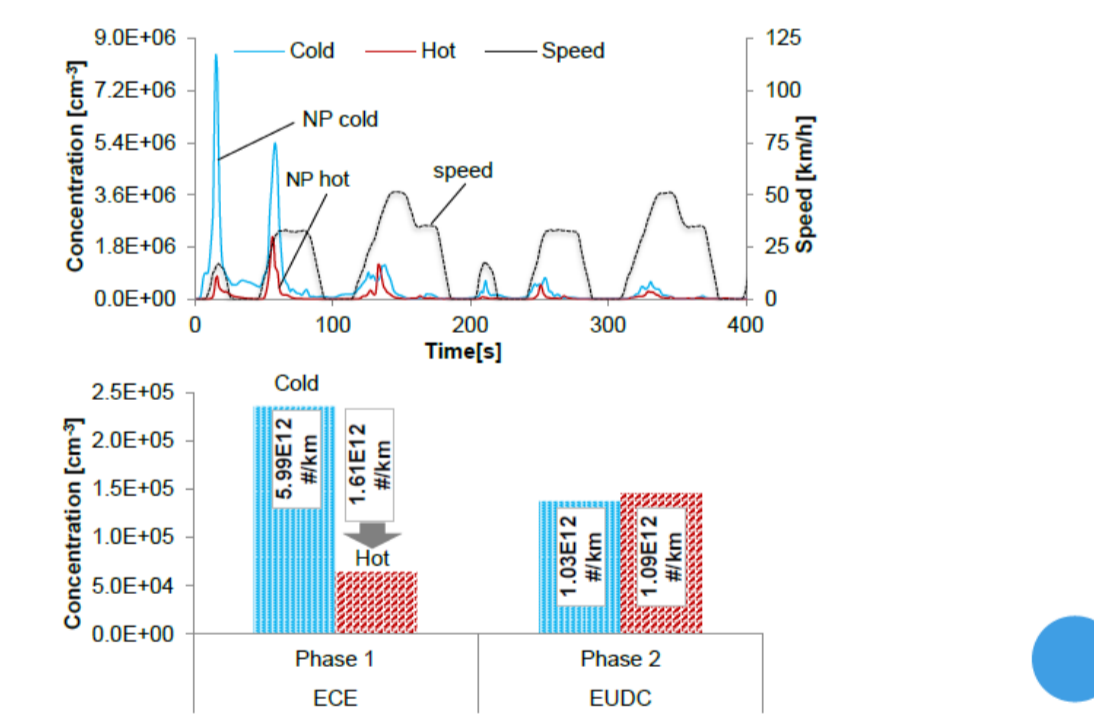

## COMPARISONS OF NP-RESULTS IN NEDC & WLTC HOT. CVS TUNNEL; GASOLINE

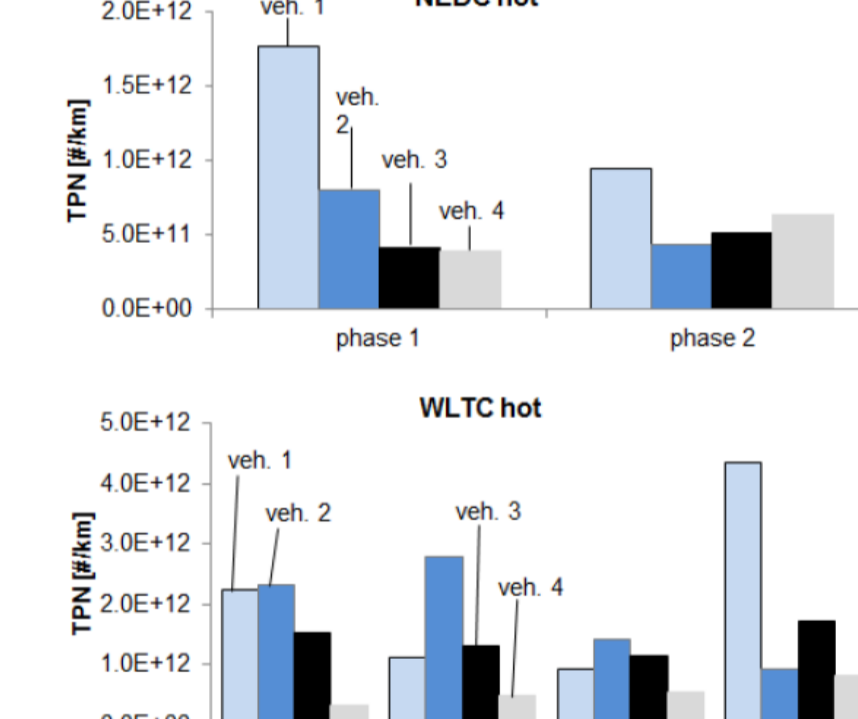

## MAJOR ELEMENTS FOUND ON THE ELPI-STAGES AFTER 10 NEDC'S. VEHICLE 3; CVS TUNNEL

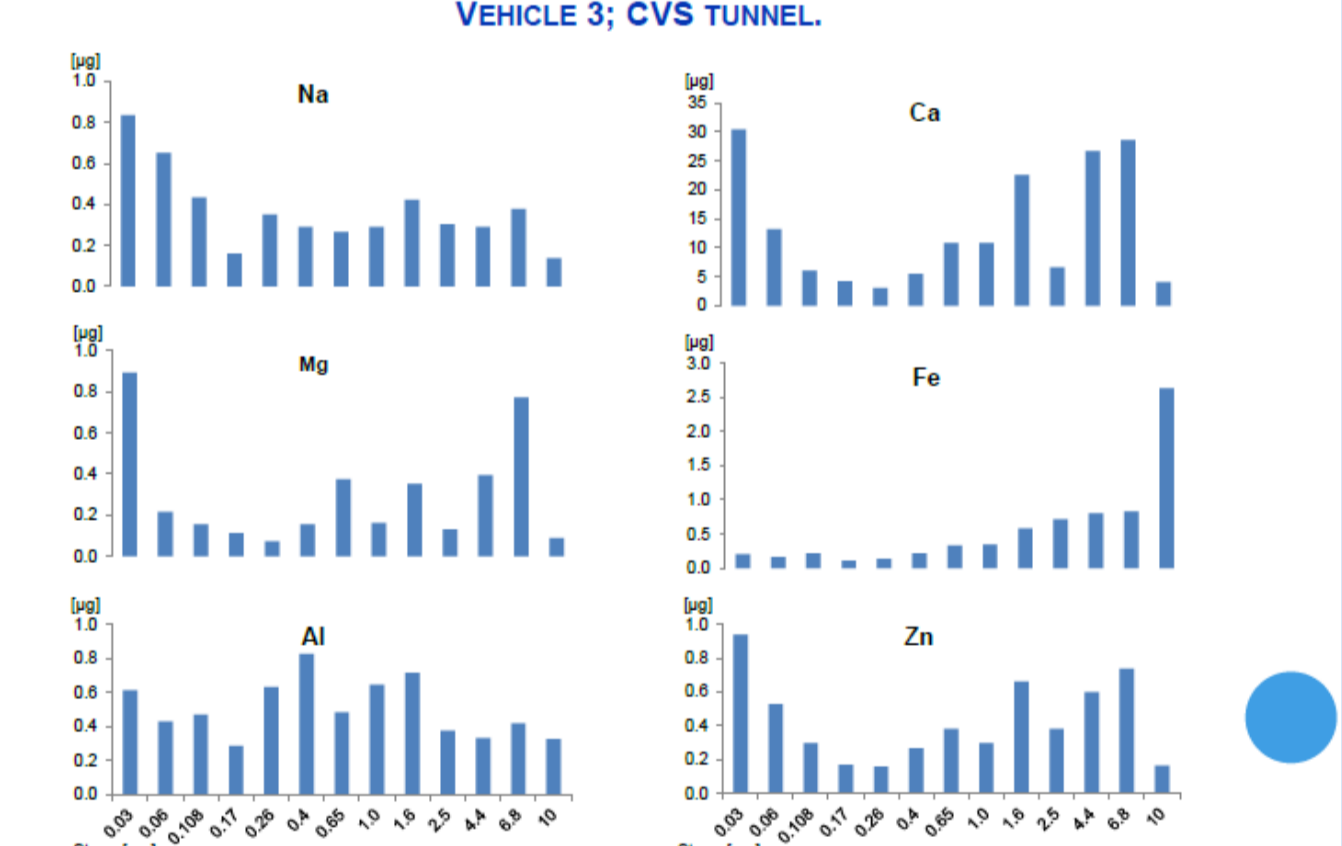

## NP-emissions along the gas way

## SAMPLING POSITION (SP) FOR TESTING THE EMISSIONS ALONG THE GAS WAY

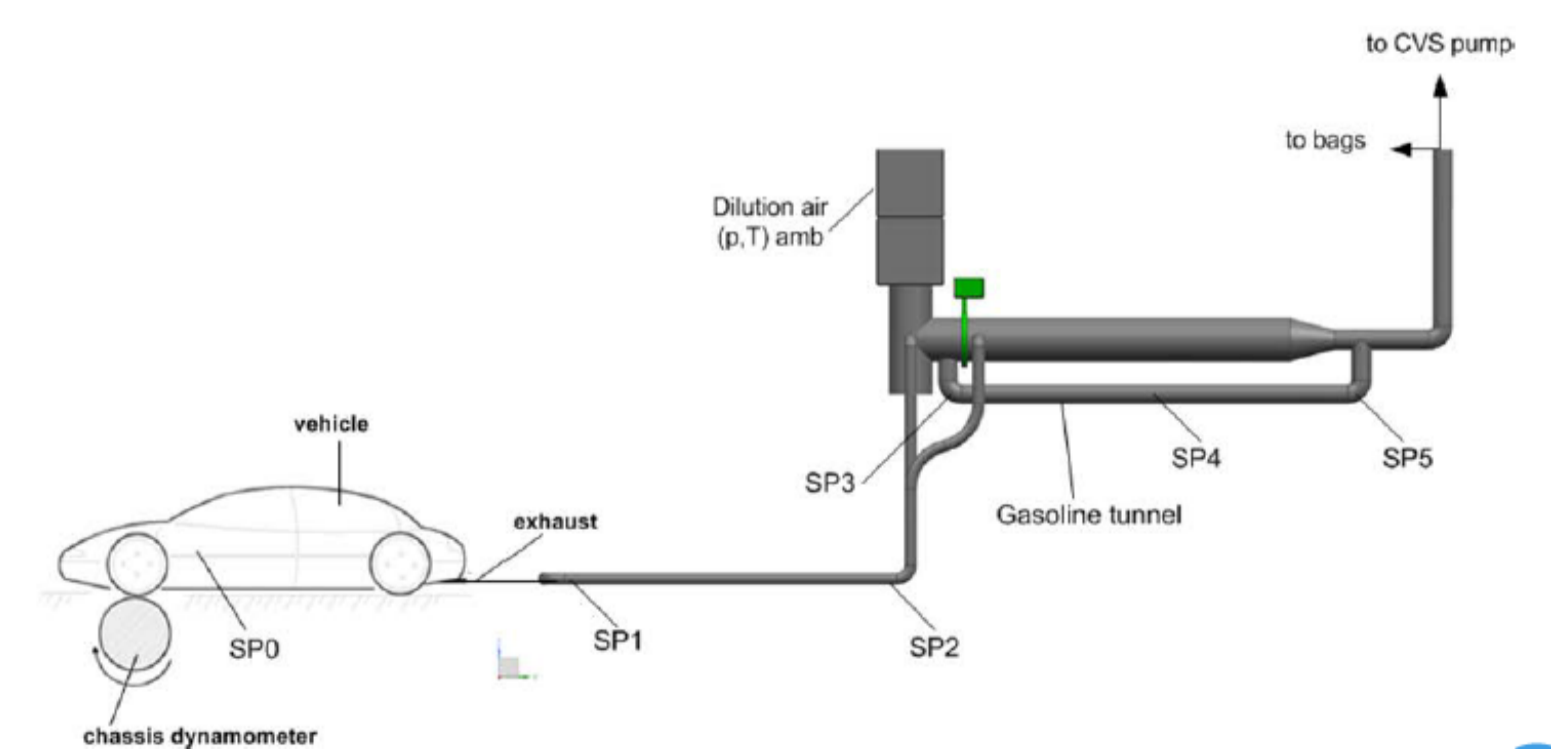

## NP-EMISSIONS AT DIFFERENT SAMPLING POSITIONS (SP). VEHICLE 4; 40 KM/H; 2ND GEAR.

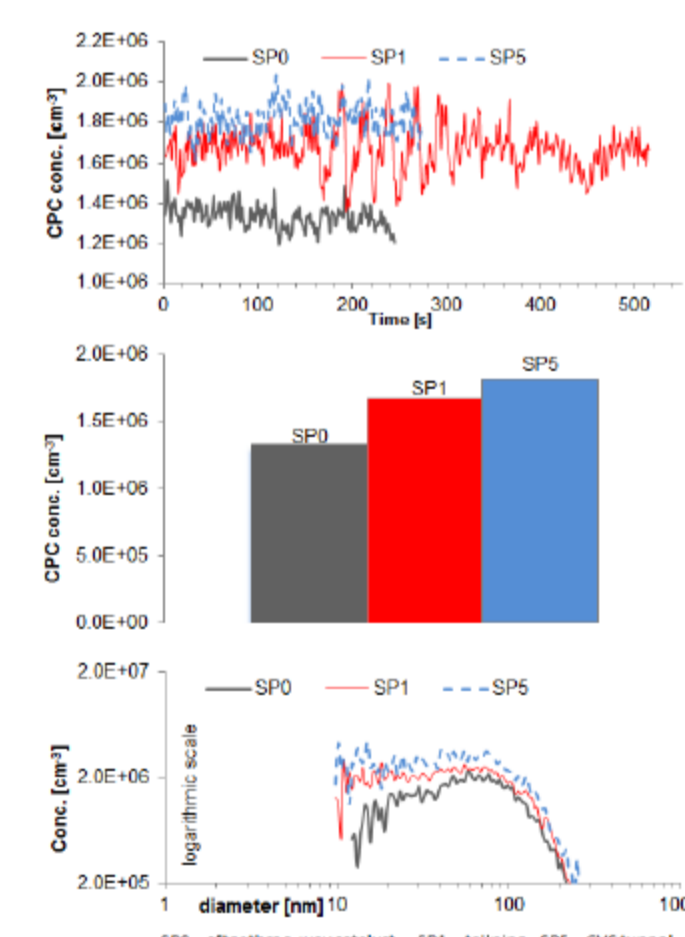

## Conclusions

- the older model with MPI (vehicle 1) emits at the stationary part load operation up to 4 orders of magnitude more nanoparticles,
- for the low-emitting vehicle there are sporadic NP-emission peaks and no clear shape of particle size distribution,
- for the vehicles with DI (vehicle 2, 3 & 4) there is no increase of PC's in nuclei mode (below 10 nm) at the measured constant speeds,
- the NP emitted at cold start (20-25°C) of a NEDC, or WLTC are roughly 4 to 5 times higher than with the hot start,
- in the last phases of WLTC with higher accelerations, with higher speeds and more energy needed for

accelerations, there is a highest level of NP-emissions,

- there is a good repeatability of the average emissions in the "warm" driving cycles,
- 10 NEDC's allow the accumulation of enough particles on the ELPI-stages, to enable the size-selective substance analysis,
- the most important substances found after 10 NEDC's in the 3 lowest stages (sizes: 0,03; 0,06; 0,108;  $\mu\text{m}$ ) were: Na, Mg, Ca and Zn,
- there is an increase of particle counts along the gas way due to the increasing nuclei mode,
- due to the electronic regulation of the engine the NP-emission of some vehicles (here vehicle 3 & 4) are periodically fluctuating,
- comparing the NP-emissions of different vehicles with SMPS PSD's at constant operation gives only a limited information about the relationships of emissions measured with CPC in dynamic driving cycles.