



How to Extend the Real Drive Emission Test Procedure to Particle Number

18th ETH Conference on Combustion Generated Nanoparticles

25th June 2014

Zurich

Francesco Riccobono, Barouch Giechaskiel, Martin Weiss, Pierre Bonnel

European Commission – Joint Research Centre

Institute for Energy and Transport



The regulatory framework /1

Regulation No 715/2007

The Commission should keep under **review** the need to **revise** the **New European Drive Cycle** as the test procedure that provides the basis of EC type approval emissions regulations. Updating or replacement of the test cycle may be required to reflect changes in vehicle specification and driver behaviour. **Revisions** may be necessary to **ensure** that **real world emissions correspond** to those **measured at type approval**. The use of **portable emission measurement systems** and the introduction of the 'not-to-exceed' regulatory concept **should also be considered**.





The regulatory framework /2

Regulation No 459/2012

Attention shall be given to the **particle emissions** of **positive ignition vehicles** under **real driving conditions** and the development of respective test procedures. The Commission should develop and introduce corresponding measurement procedures at the latest **three years after** the entry into force of **Euro 6**.





The impact

- *Euro 6 standard on particle number (PN) for gasoline direct injection vehicles (GDIs):*
 - September 2014 6×10^{12} p/km*
 - September 2017 6×10^{11} p/km.*





The impact

- *Euro 6 standard on particle number (PN) for gasoline direct injection vehicles (GDIs):*
 - September 2014 6×10^{12} p/km*
 - September 2017 6×10^{11} p/km.*
- *Possibility of compliance through improvements in the combustion process without the need of Gasoline Particulate Filter (GPF).*





The impact

- *Euro 6 standard on particle number (PN) for gasoline direct injection vehicles (GDIs):*
 - September 2014 6×10^{12} p/km*
 - September 2017 6×10^{11} p/km.*
- *Possibility of compliance through improvements in the combustion process without the need of Gasoline Particulate Filter (GPF).*
- *The introduction of a Real Drive Emission (RDE) test procedure for PN might require the installation of GPFs to comply with the new complementary test procedure.*





Real Drive Emission tests

1 - Emissions testing with random driving cycles in the laboratory





Real Drive Emission tests

1 - Emissions testing with random driving cycles in the laboratory

2- On-road emissions testing with Portable Emissions Measurement Systems (PEMS)





Real Drive Emission tests

1 - Emissions testing with random driving cycles in the laboratory

2- On-road emissions testing with Portable Emissions Measurement Systems (PEMS)





Call for expression of interests (November 2012)

Development of a test protocol to measure Particle Number (PN) on board of light-duty vehicles for type approval testing using Portable Emissions Measurement Systems (PEMS)





Phase I - feasibility study

Aim

Assess and validate the application and performance of portable PN instrumentation relative to each other and to a reference.





Phase I - feasibility study

Aim

Assess and validate the application and performance of portable PN instrumentation relative to each other and to a reference.

Evaluation criteria

- Linearity of the portable PN system with the reference system under controlled laboratory conditions (chassis dyno tests)
- Performance of long sampling on-board





Experimental setup

- **5 candidate PN-PEMS instruments**
 - **5 vehicles** (3 GDI, 1 MPI and 1 Diesel w/DPF)
 - **4 cycles** (NEDC, WLTP, RDE, ARTEMIS) + 3 Steady States at 8°C and 23°C
 - **~ 120 chassis dyno tests**
- Comparison of PN-PEMS (all in parallel) with PMP @CVS (reference)





Experimental setup

- **5 candidate PN-PEMS instruments**
- **5 vehicles** (3 GDI, 1 MPI and 1 Diesel w/DPF)
- **4 cycles** (NEDC, WLTP, RDE, ARTEMIS) + 3 Steady States at 8°C and 23°C
- **~ 120 chassis dyno tests**

Comparison of PN-PEMS (all in parallel) with PMP @CVS (reference)

- **On-road tests** (1 GDI vehicle)
4 PN-PEMS candidates (1 at a time) +
1 Reference candidate instrument always on board +
1 Gas-PEMS
Two types of tests: 1 and 2 hour long



The reference: PMP system

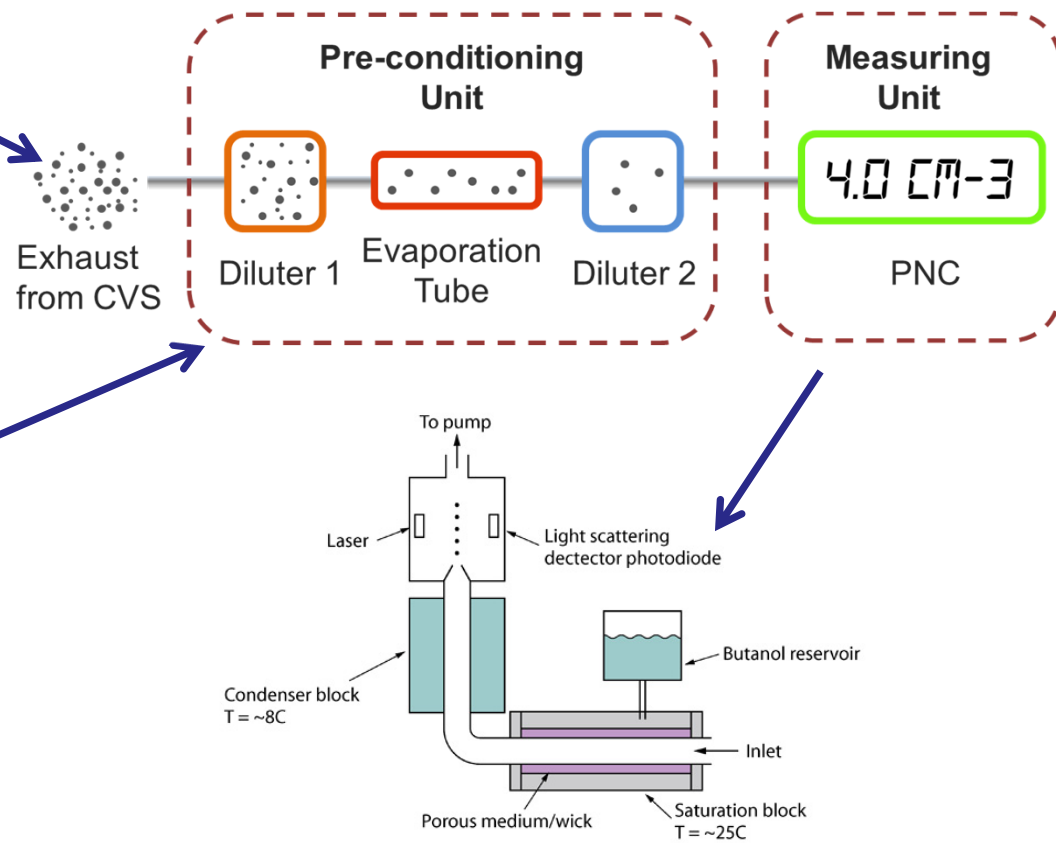

Candidate PN-PEMS systems



5 instruments (3 on market + 2 prototype)

All based on diffusion charging principle

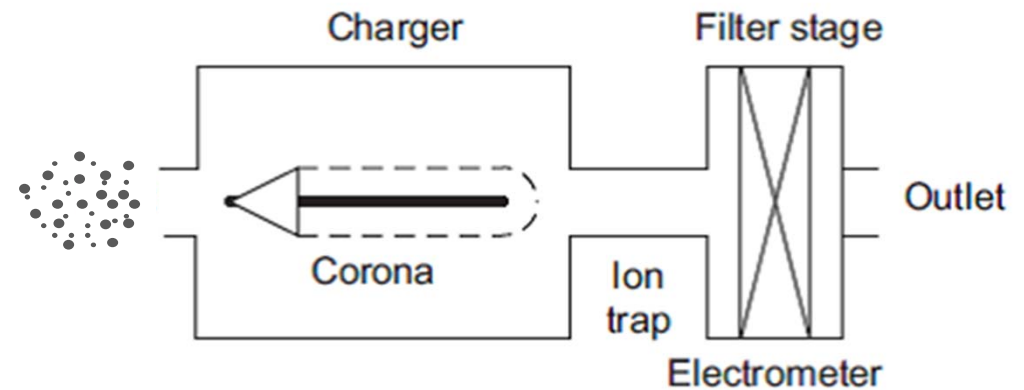

PMP vs PN-PEMS times series

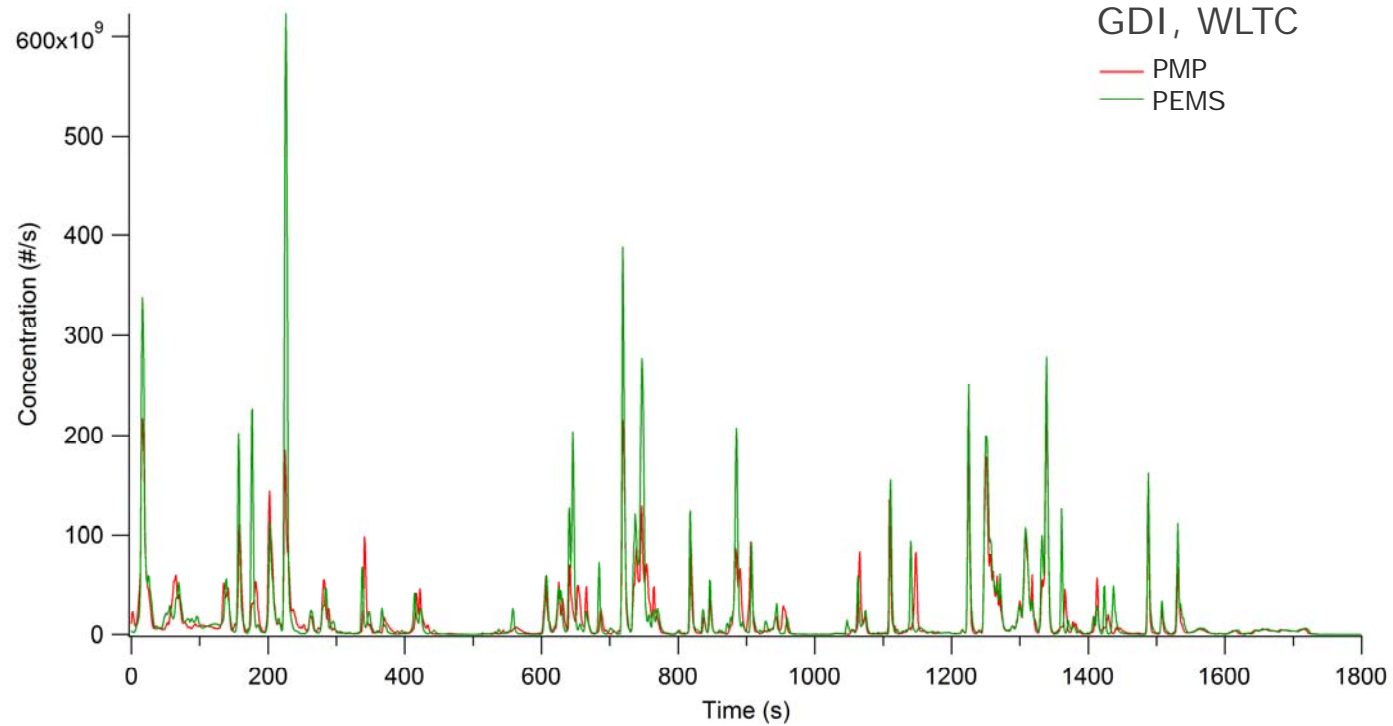

PMP vs PN-PEMS times series (log scale)

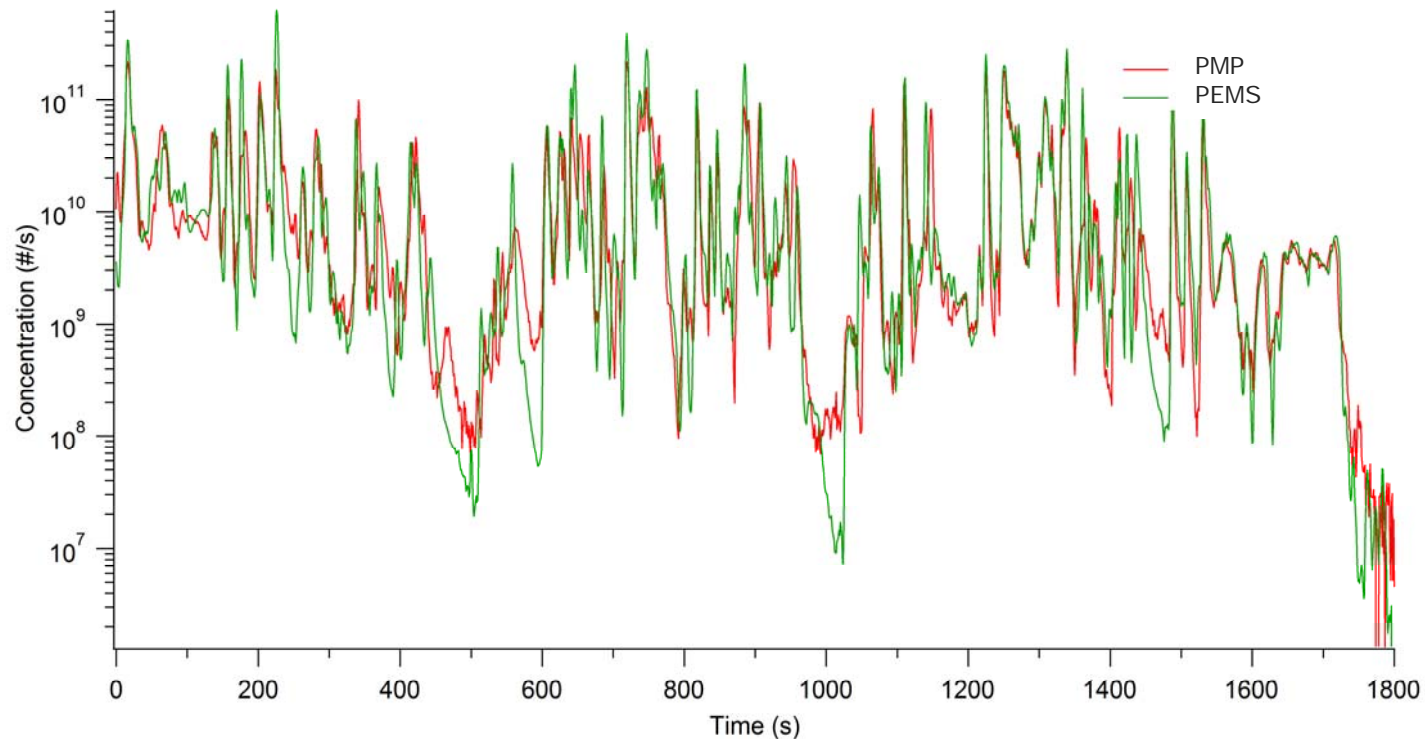

Unavoidable time misalignment due to **different response time** of the systems and **time delay** between tailpipe and CVS: Reported results are cycle average emission factor **#/km**



European
Commission

PN-PEMS vs PMP

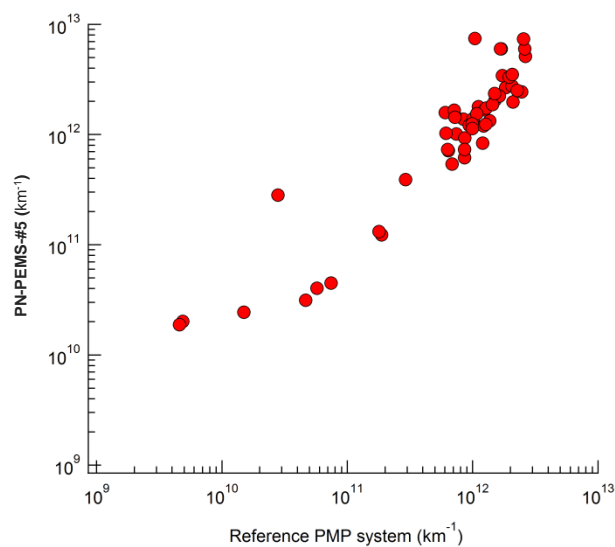
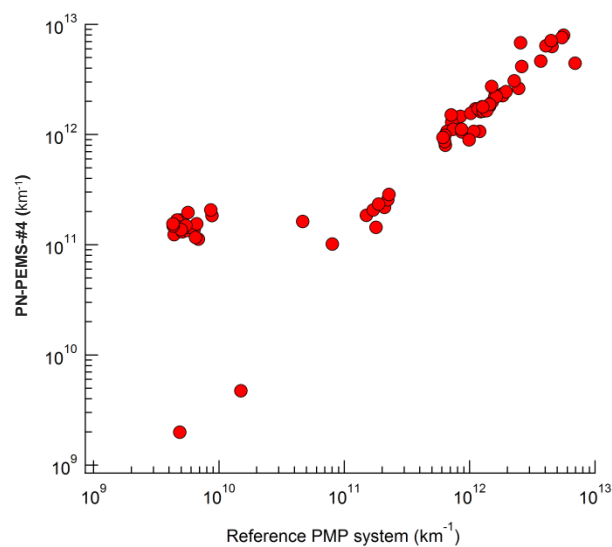
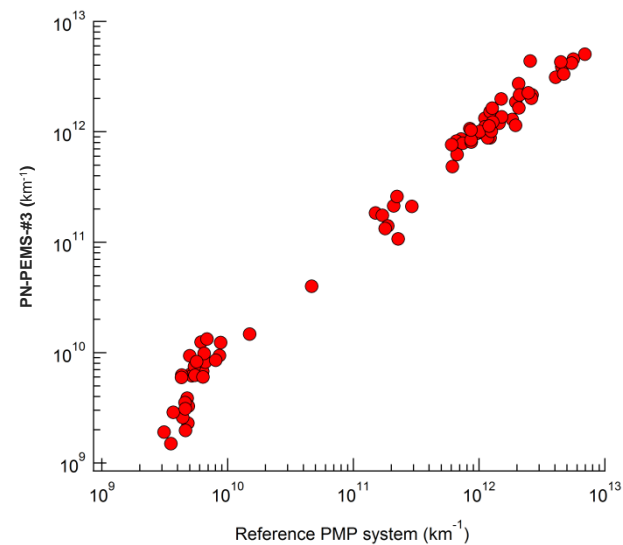
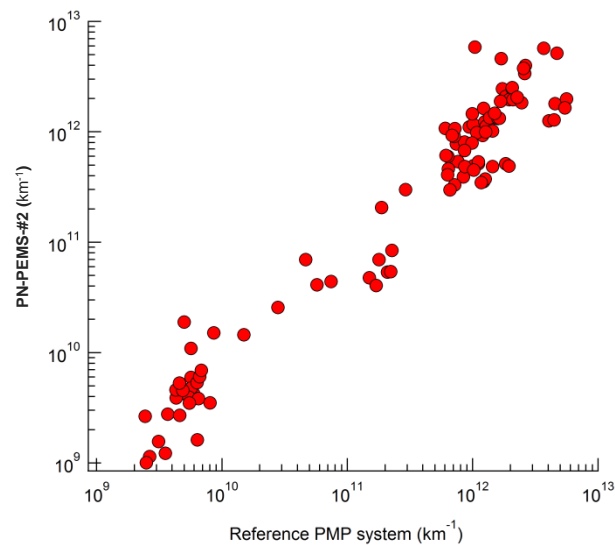
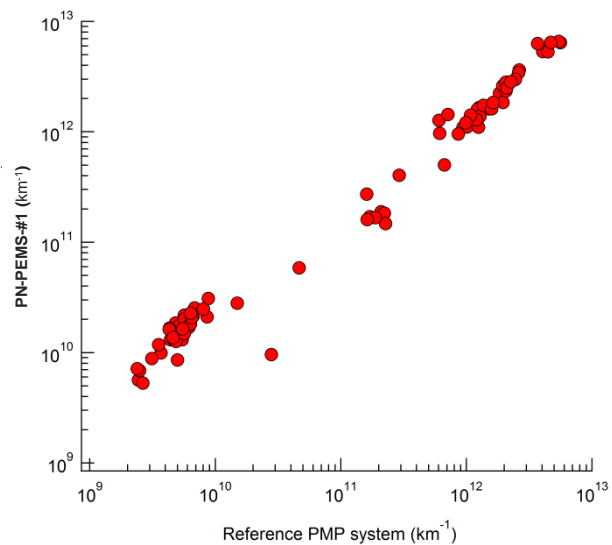



European
Commission

PN-PEMS vs PMP

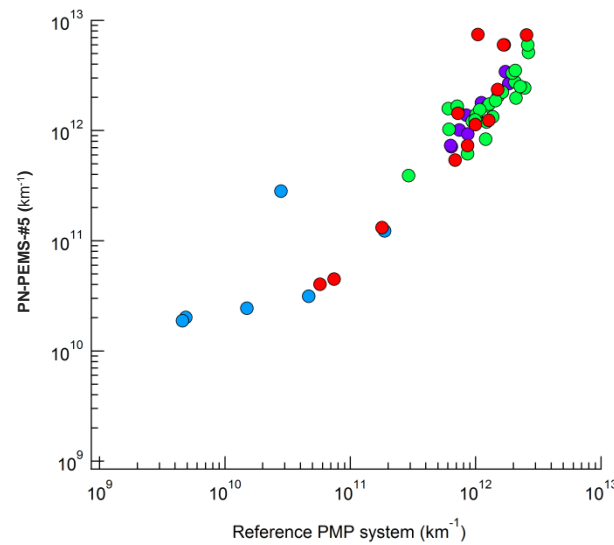
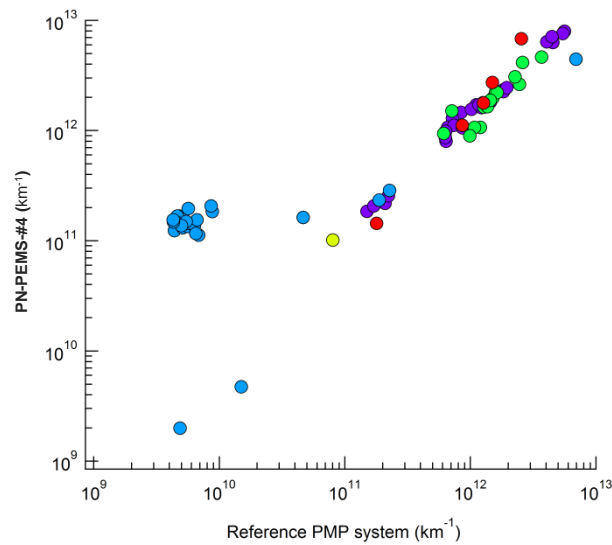
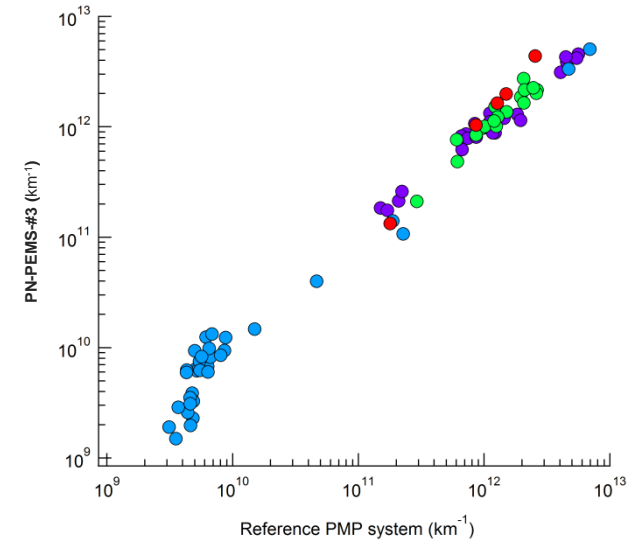
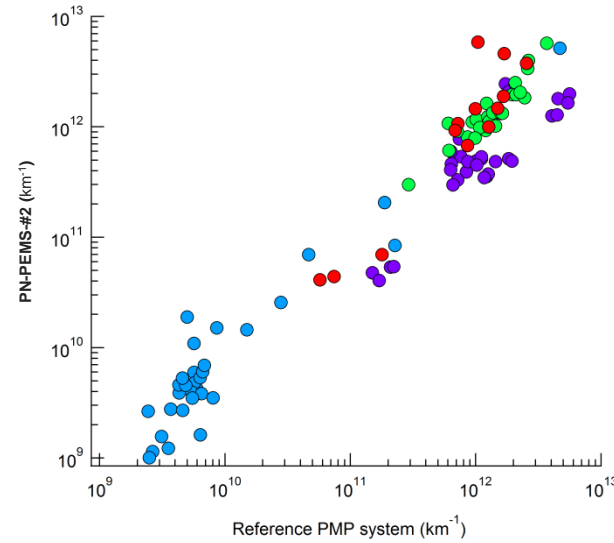
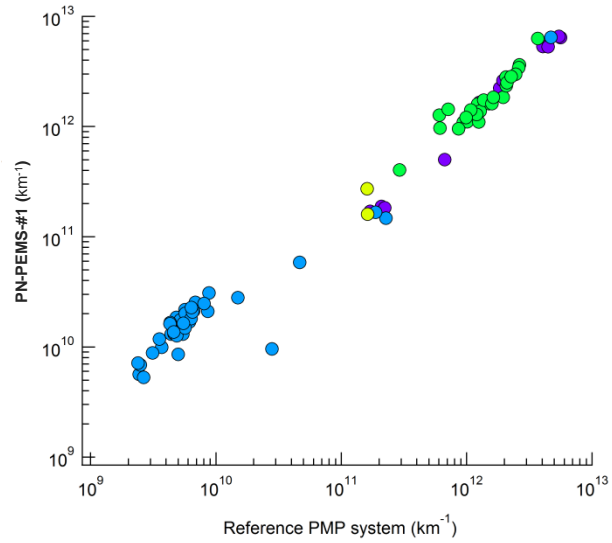

- GDI 1
- DPF
- GDI 2
- MPI
- GDI 3



European
Commission

PN-PEMS vs PMP

- GDI 1
- DPF
- GDI 2
- MPI
- GDI 3

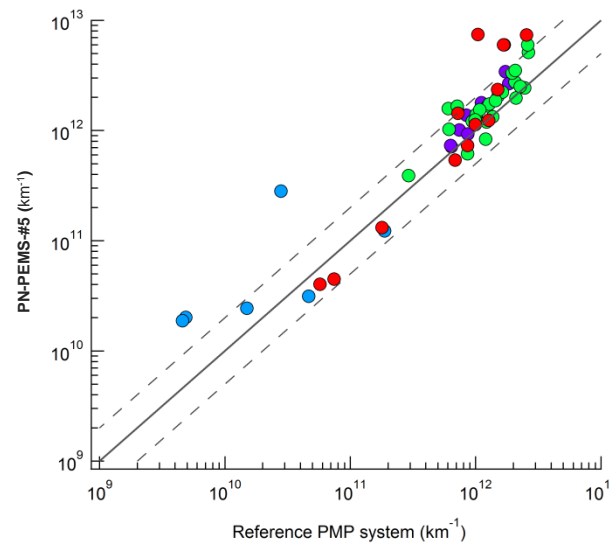
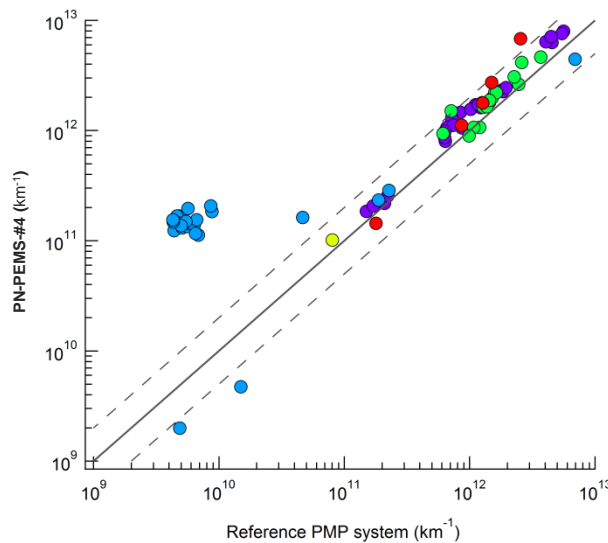
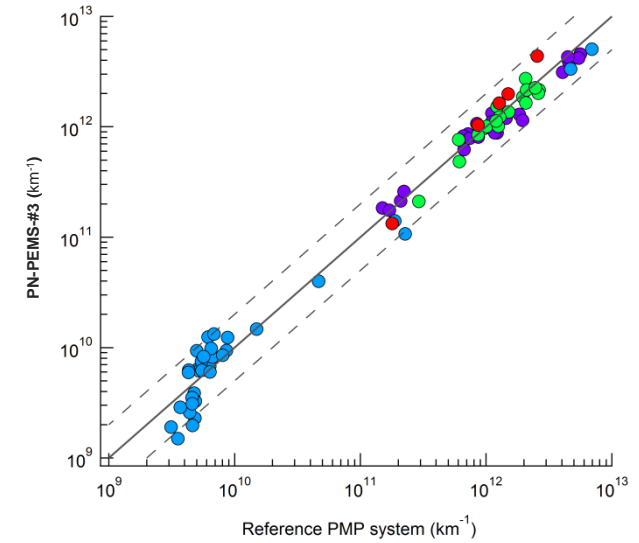
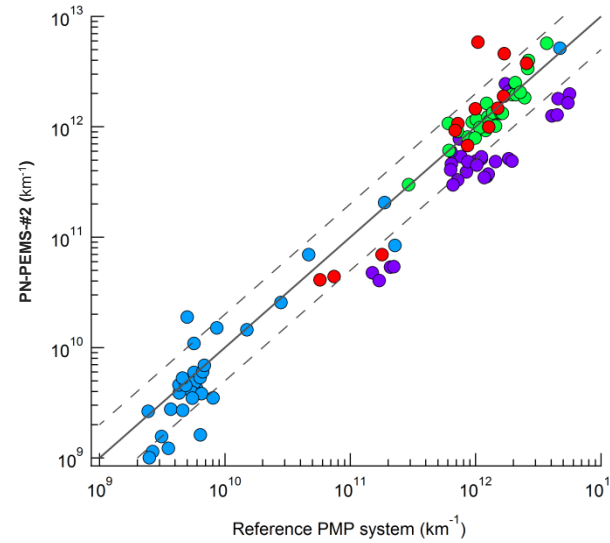
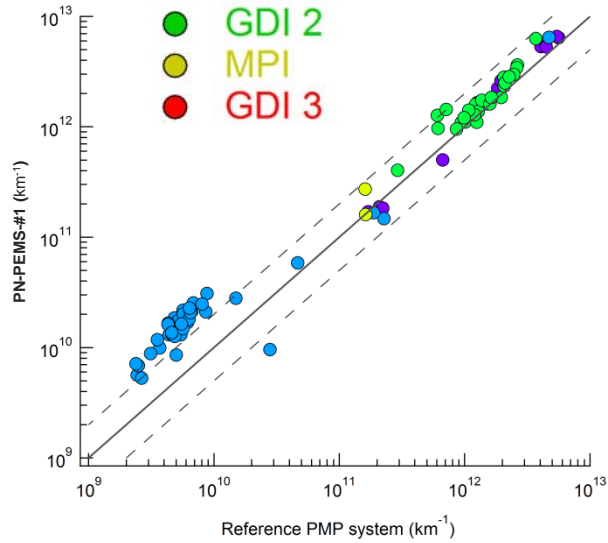

Current best case:
PN-PEMS vs PMP @ CVS
95% data points
fall within
+100% -50%



European
Commission

PN-PEMS vs PMP

- GDI 1
- DPF
- GDI 2
- MPI
- GDI 3

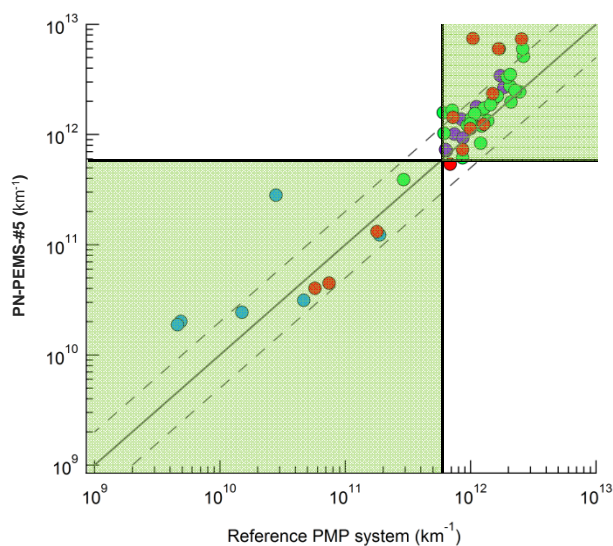
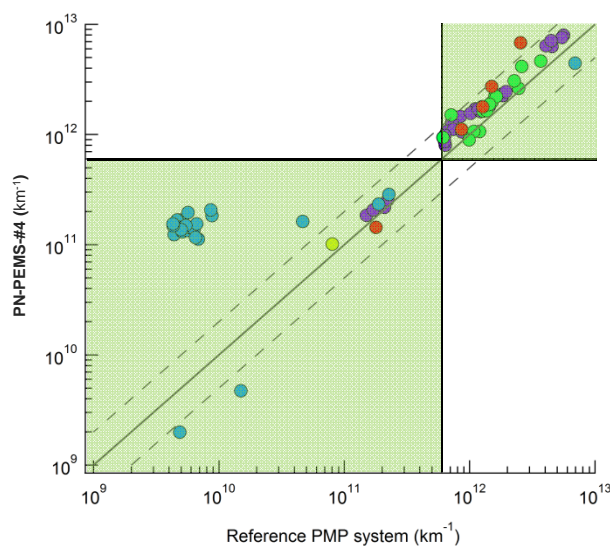
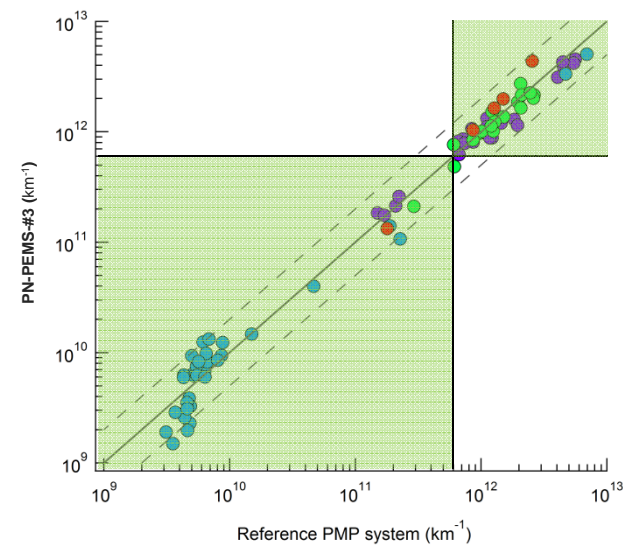
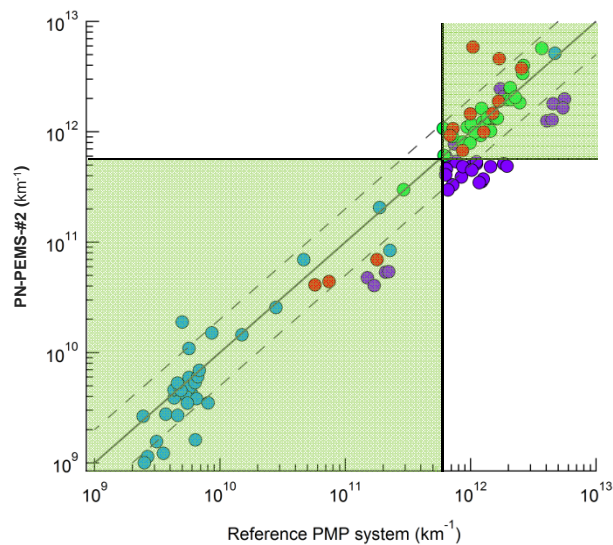
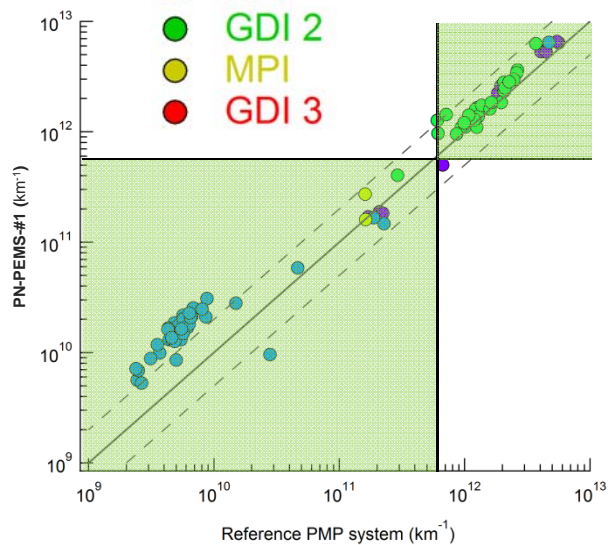

Pass/Fail test
relaxes the
requirements
far from the
standard value

Effect of ambient temperature

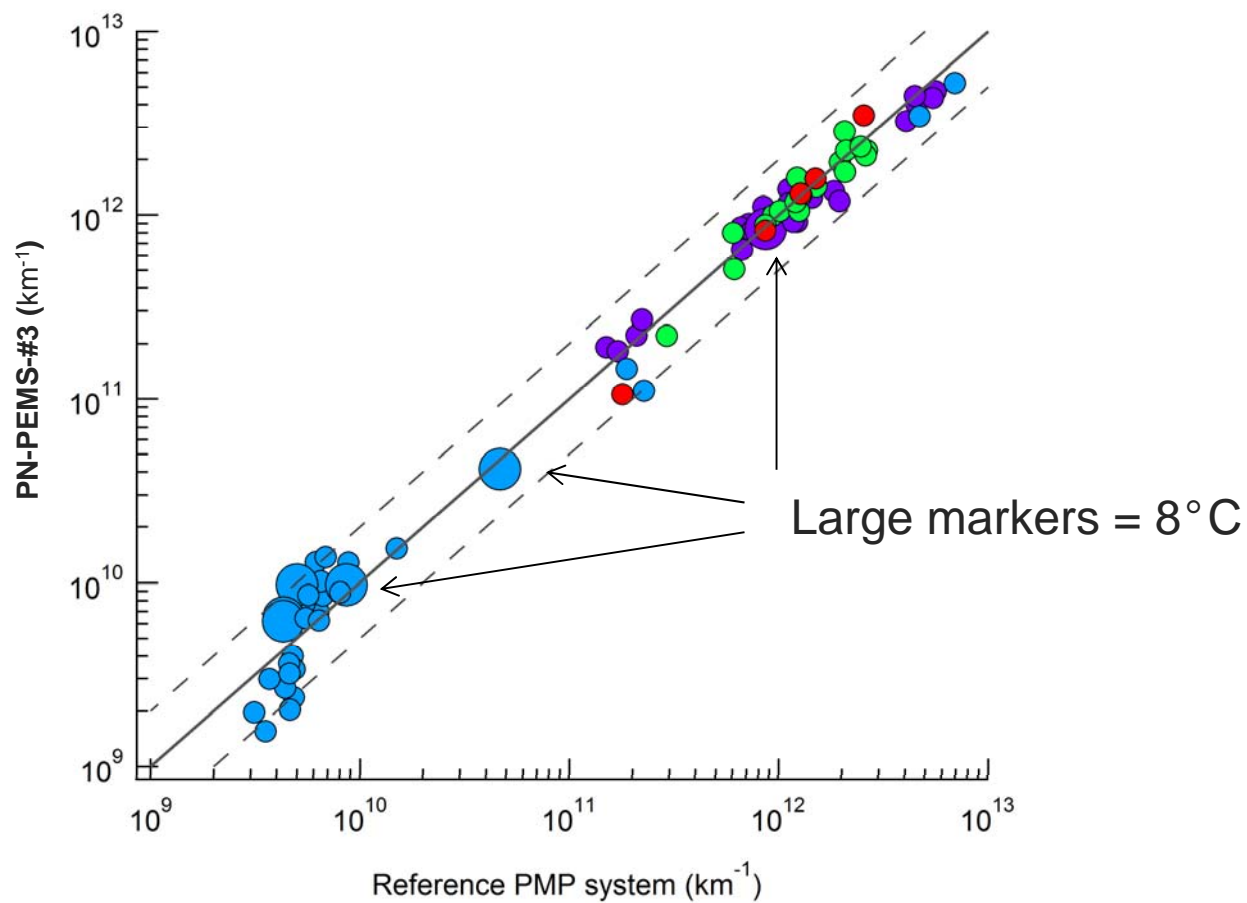

Critical conditions: Regeneration

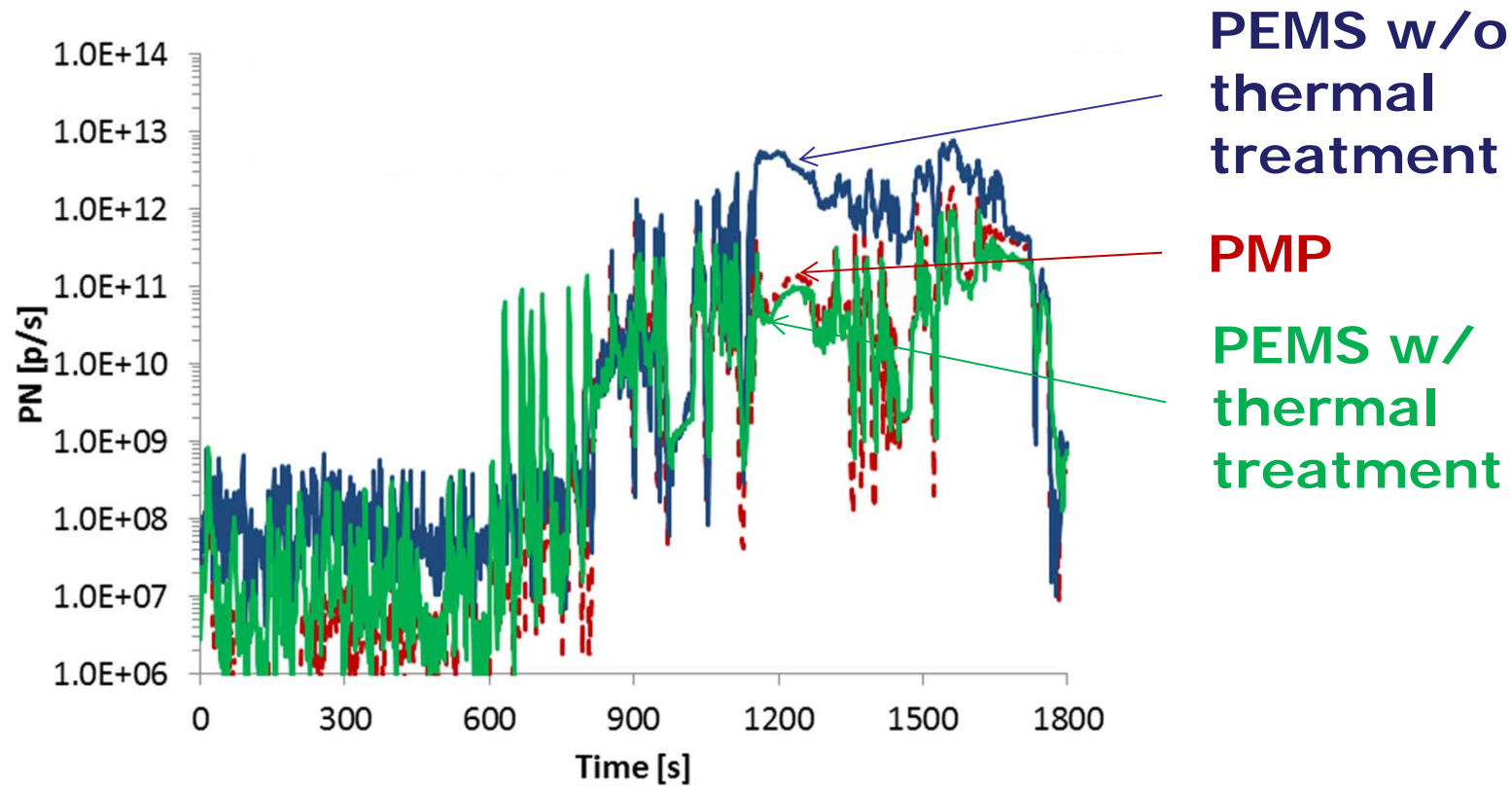

Thermal treatment is needed!





Conclusions

- *Diffusion charging resulted in a promising alternative to CPCs for PEMS measurements*





Conclusions

- *Diffusion charging resulted in a promising alternative to CPCs for PEMS measurements*
- *Based on the first results, the estimated measurement variability is 2*





Conclusions

- *Diffusion charging resulted in a promising alternative to CPCs for PEMS measurements*
- *Based on the first results, the estimated measurement variability is 2*
- *Standardized instrument design (e.g. thermal treatment, dilution) and calibration could reduce the allowance factor to 1.5 (Phase II)*





Outlook

- *List of technical performance requirements is being drafted*





Outlook

- *List of technical performance requirements is being drafted*
- *Instrument manufacturers are currently upgrading the devices (new devices are under development)*





Outlook

- *List of technical performance requirements is being drafted*
- *Instrument manufacturers are currently upgrading the devices (new devices are under development)*
- *Phase II will start in October 2014 with the aim of developing the test procedure*





Outlook

- *List of technical performance requirements is being drafted*
- *Instrument manufacturers are currently upgrading the devices (new devices are under development)*
- *Phase II will start in October 2014 with the aim of developing the test procedure*
- *It will be based on the gas-PEMS test procedure*





Outlook

- *List of technical performance requirements is being drafted*
- *Instrument manufacturers are currently upgrading the devices (new devices are under development)*
- *Phase II will start in October 2014 with the aim of developing the test procedure*
- *It will be based on the gas-PEMS test procedure*
- *Calibration will be specifically addressed*





Calibration possibilities

- *Calibration vs PMP in the laboratory with a defined aerosol standard and generation procedure (monodisperse and/or polydisperse).*





Calibration possibilities

- *Calibration vs PMP in the laboratory with a defined aerosol standard and generation procedure (monodisperse and/or polydisperse).*
- *Calibration (or validation) vs PMP on the chassis dyno. Similarly to what has been proposed by OEMs for gas-PEMS.*





Thanks for your attention!





European
Commission



PMP efficiency

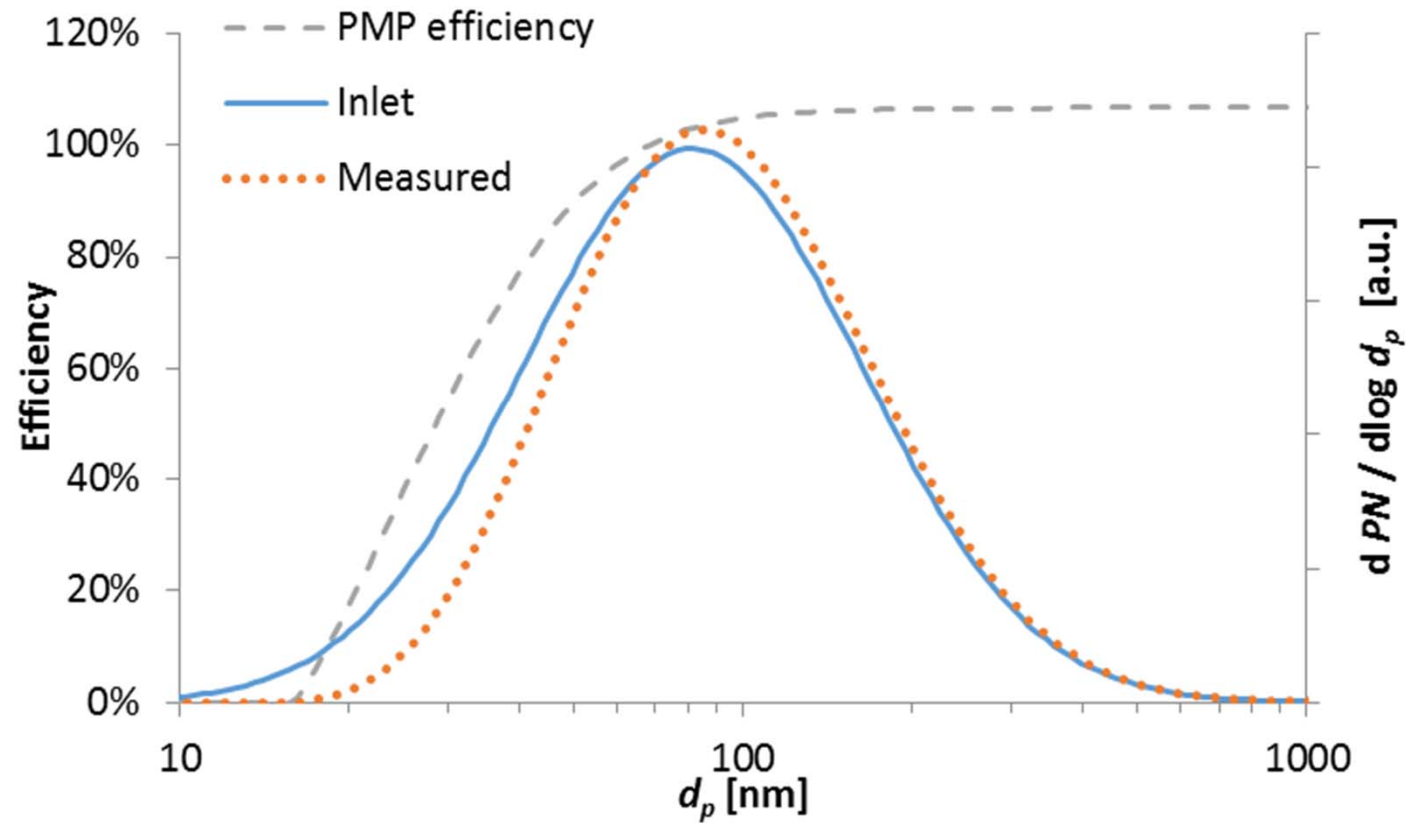

PN-PEMS efficiency

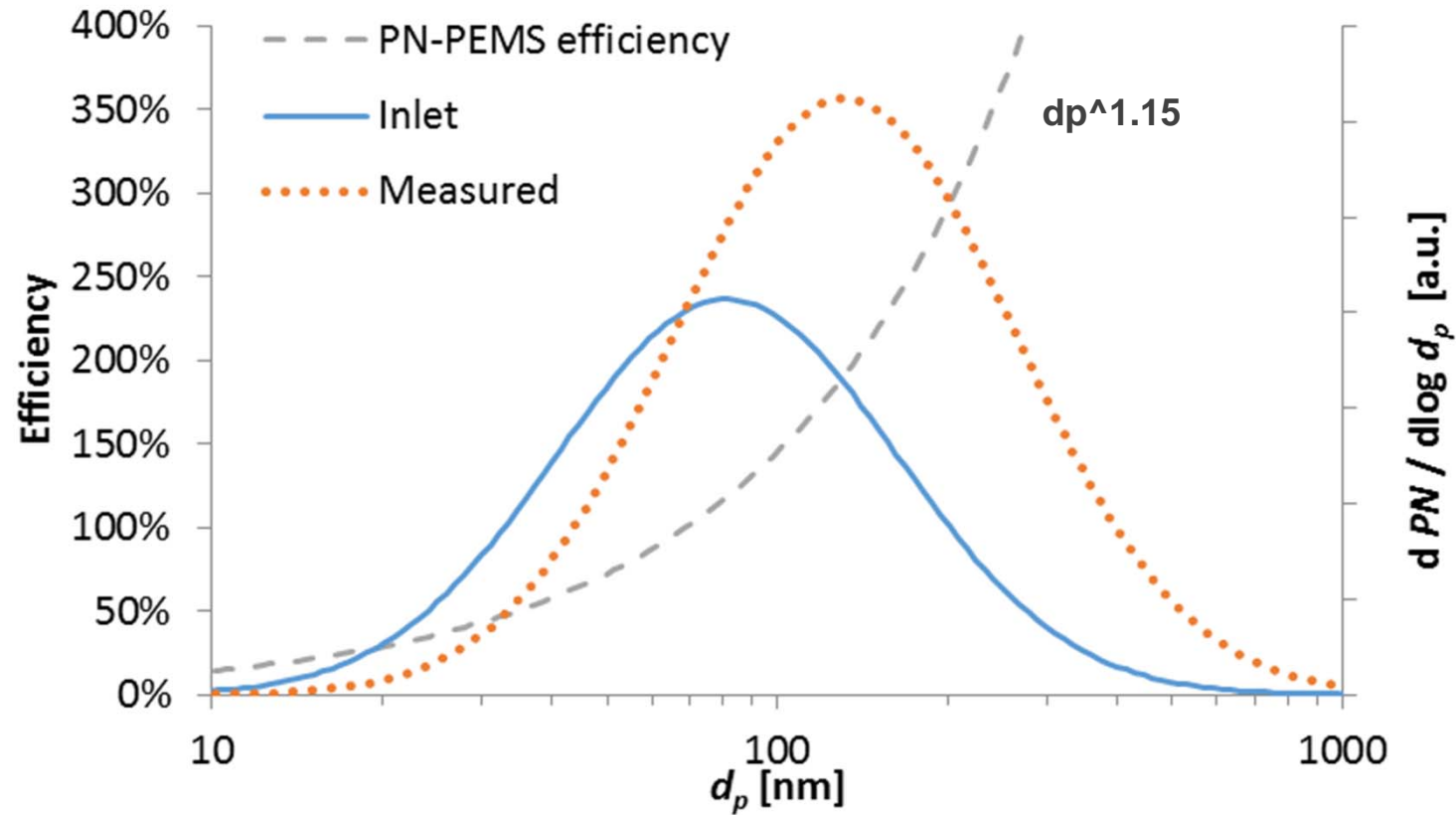

Time alignment uncertainty

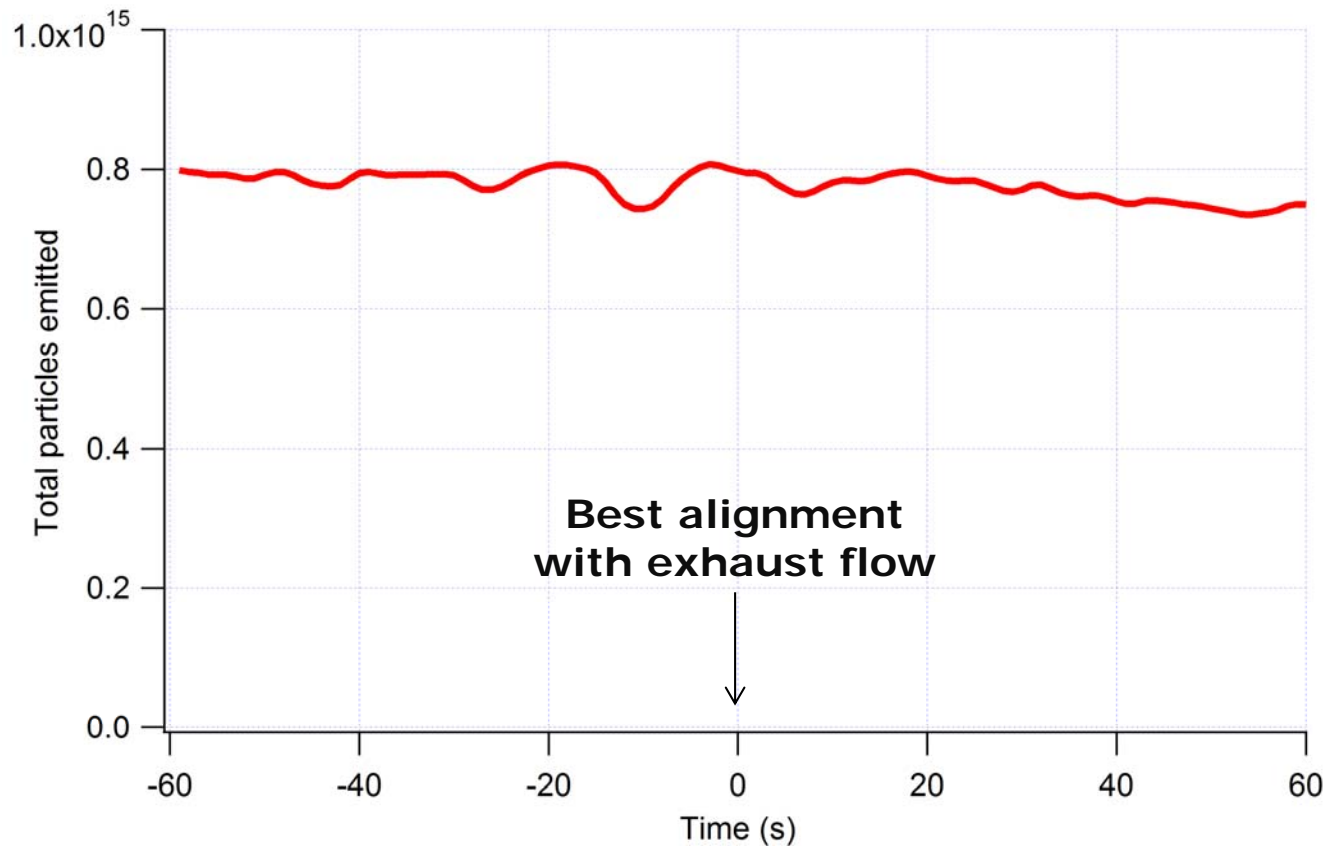

Time alignment uncertainty

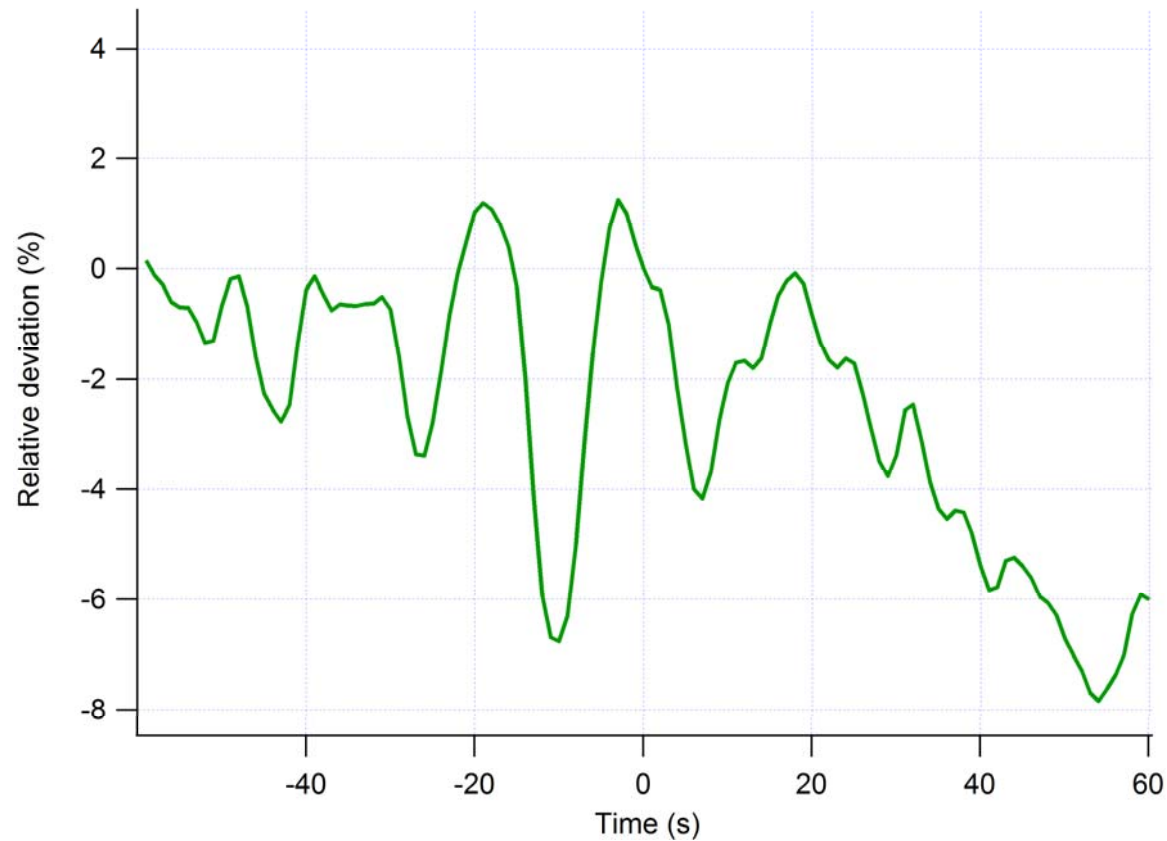

















Logging
exhaust flow
would minimize
the uncertainty

Max deviation from mean $\pm 4\%$



Summary

	Pass/Fail vs PMP 23°C ($<6e11$ km ⁻¹)	Pass/Fail vs PMP 8°C ($<6e11$ km ⁻¹)	95 th percentile within +100% - 50%	Regen	On-road
PN-PEMS-#1					
PN-PEMS-#2					
PN-PEMS-#3					
PN-PEMS-#4					
PN-PEMS-#5	